

SINCE
1954

YOUR PARTNER IN IRONING

Product Catalog 2025

widemeX
i n t e r n a t i o n a l

Hello!

Thank you for exploring our product catalog. Here, you will find a comprehensive overview of our products along with essential logistics information.

If you have any questions or require further details, please feel free to contact us at:

info@widemexinternational.com

Happy browsing!

03

ironing board covers

Selection guide

Widex

Airpro

32

drying racks

Widex

14

ironing boards

Widex

Airpro

Hotel

42

accessories

Ironing accessories

Shirtmeister

IRONING BOARD COVERS

As a manufacturer and supplier of ironing board covers, we continuously innovate while maintaining our commitment to quality. By creating a variety of ironing board covers, we ensure that every consumer can find the perfect fit. You'll be amazed by the endless possibilities in the world of ironing!

- **Oeko-Tex certified:** which means that no harmful substances have been used;
- **Made in Europe:** which means shorter transport routes and minimal CO2 emissions;
- We participate in the **Better Cotton programme**, for a sustainable cotton production



Selection guide

Especially for our customers, we've created a **selection guide** to make choosing the right ironing board cover effortless.

We know it can be tricky to find the perfect fit. The two key factors to consider are **how often you iron** and **which cover size matches your ironing board**.

On the next page, you'll find our **selection guide**—an easy-to-follow overview of our covers and their categories.

How often do you iron?

 OCCASIONAL USE	Occasionally: I iron every two weeks or less
 FREQUENT USE	Frequently: I iron every two weeks or more
 INTENSIVE USE	Intensively: I iron once a week or more

What size cover do you need?



CM	30-38	39-42	43-52
100-119	S/M S1/T1	S/M S1/T1	
120-125	S/M S1/T1	S/M S1/T1	L/XL S2/T2
126-140		L/XL S2/T2	L/XL S2/T2



OCCASIONAL USE

I'd like a basic cover



BASIC

This ironing board cover may be a basic version, but no concessions have been made to the quality.

I'd like a good and affordable cover



CLASSIC

The classic ironing board cover made of cotton and foam is of good quality and affordable. This 100% cotton ironing board cover is extra steam permeable due to the foam layer. This model is ideal for people who iron occasionally.



FREQUENT USE

I'd like to save time & energy



ALU PERFO

This ironing board cover of 100% cotton with an extra thick molton lining is known for its dual ironing effect. The Aluminum coating reflects the heat of your iron. Saving you time and energy!

I'd like extra comfort



COMFORT

Iron more comfortably. Thanks to the extra thick molton underlayer, your iron glides over your laundry and makes a perfect ironing result extra easy.

I'd like an extra durable cover



TITANIUM

This titanium treated, perforated cotton ironing board cover resists high temperatures for long-lasting comfort, with optimal heat reflection and improved steam diffusion.

I'd like an easy application



EASY FIX

Easy-Fix ironing board covers are produced with an elastic hem for a quick and easy application of the cover.

I'd like to park my hot iron anywhere

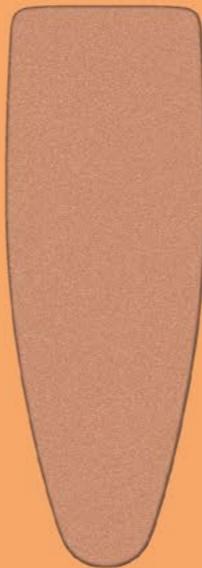

100% PARKING

This 100% specially treated aluminized cover ensures safe ironing, resisting up to 200°C for 10 minutes—so you can park your hot iron anywhere! Cotton perforation allows optimal steam diffusion.

I'd like an eco-friendly cover



ECO-RESPONSIBLE

With respect for the environment and looking after our planet, Widemex offers you an environment friendly ironing board cover. Composed of 67% recycled materials.



INTENSIVE USE

I'd like to park and clean my iron

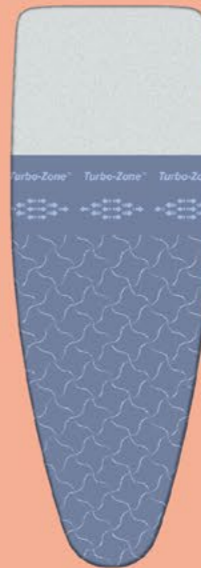

TURBO & PARKING

This ironing board cover has a safe Parking Zone for your iron and a Turbo Zone® for extra speed. Place your heated iron on the patented Parking Zone without risk of burns, and glide it over the Turbo Zone® three times for a like-new smoothness!

I'd like a professional cover



ACTIVE

Designed for steam generators and high-steam irons, this 5-layer cover prevents condensation and water droplets on your floor.

I'd like the crème de la crème



airpro

This extra-durable ironing board cover features special heat reflection, allowing a lower iron temperature. Its thick 6-layer design speeds up ironing by 50% while preventing condensation and water puddles.

REDUCED IRONING TIME, INDEPENDENTLY TESTED BY HOHENSTEIN TEST REPORT 24/1106673



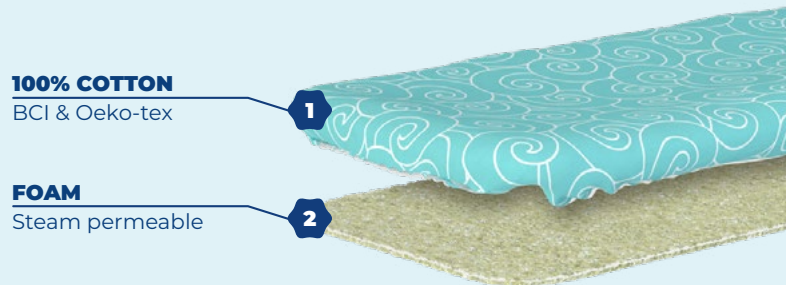
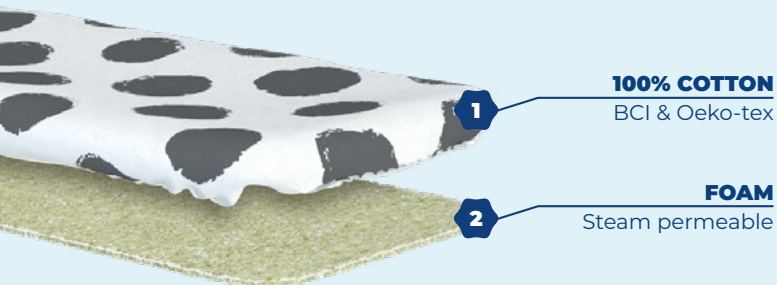

BASIC



2 layers | couches | lagen | Lagen | warstwy

This ironing board cover may be a basic version, but no concessions have been made to the quality.

PRODUCT SIZE 18x3x26 cm	PACKAGE SIZE 39x23,5x30 cm	PCS / BOX 24	PCS / PALLET 1.200
BOX / LAYER 10	LAYERS / PALLET 5	PALLET SIZE 120x80x210 cm	PCS / TRUCK 39.600

Basic REF. 23020 EAN: 8710225230206

CLASSIC



2 layers | couches | lagen | Lagen | warstwy

This classic made of cotton and foam is of good quality and affordable. The cover is extra vapor permeable due to the thick foam layer.

PRODUCT SIZE 22x3x37 cm	PACKAGE SIZE 39x23,5x30 cm	PCS / BOX 14	PCS / PALLET 700
BOX / LAYER 10	LAYERS / PALLET 5	PALLET SIZE 120x80x210 cm	PCS / TRUCK 23.100

Taille 1 S/M REF. 652 EAN: 8710225006528

Taille 2 L/XL REF. 653 EAN: 8710225006535

* Non binding photos

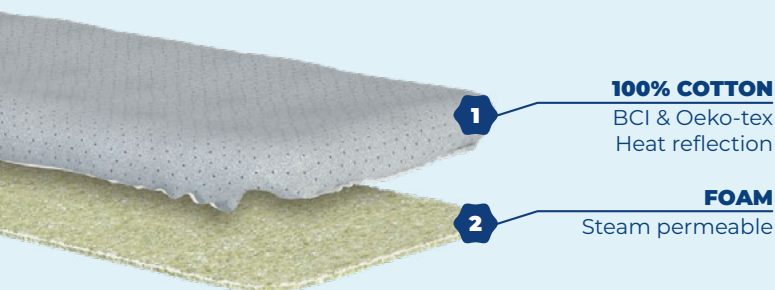

100% COTTON
BCI & Oeko-tex

FOAM
Steam permeable

FELT
Ironing comfort

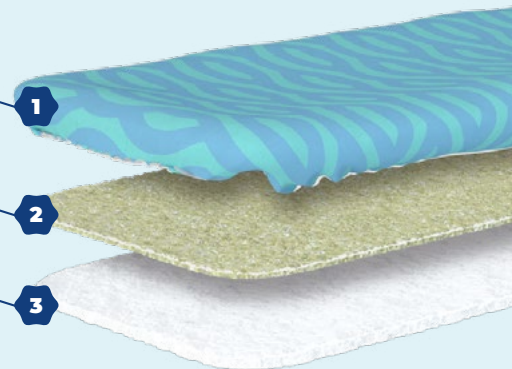

ALU PERFO



COMFORT



2 layers | couches | lagen | Lagen | warstwy

Reflection & diffusion: Aluminized cotton for a good heat reflection. Perforations for a better steam diffusion.

3 layers | couches | lagen | Lagen | warstwy

Iron more comfortably. The thick molton underlayer, makes your iron glide smoothly making a perfect ironing result extra easy.

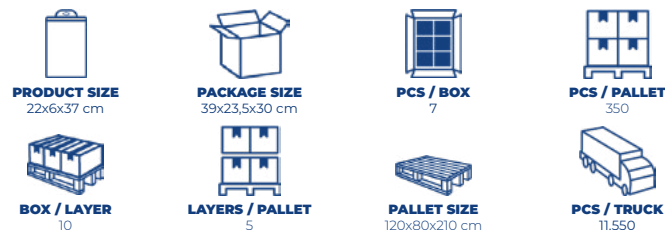
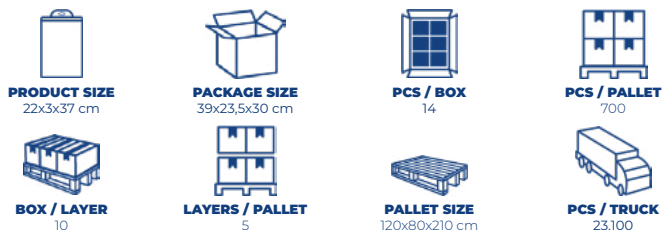

Taille 1 S/M	REF. 742	EAN: 8710225007426
Taille 2 L/XL	REF. 743	EAN: 8710225007433

Taille 1 S/M	REF. 641	EAN: 8710225006412
Taille 2 L/XL	REF. 642	EAN: 8710225006429

* Non binding photos

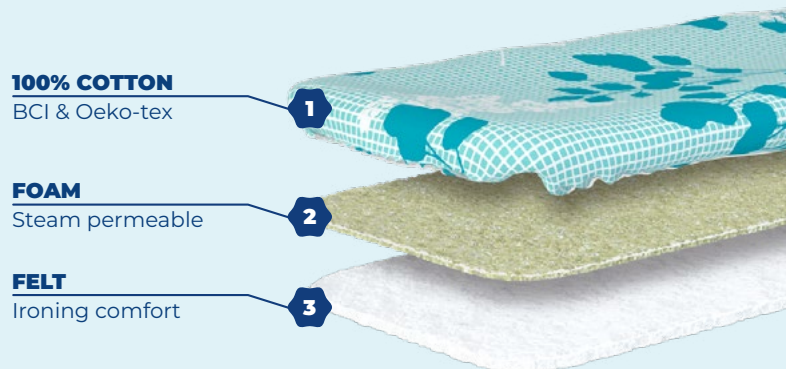
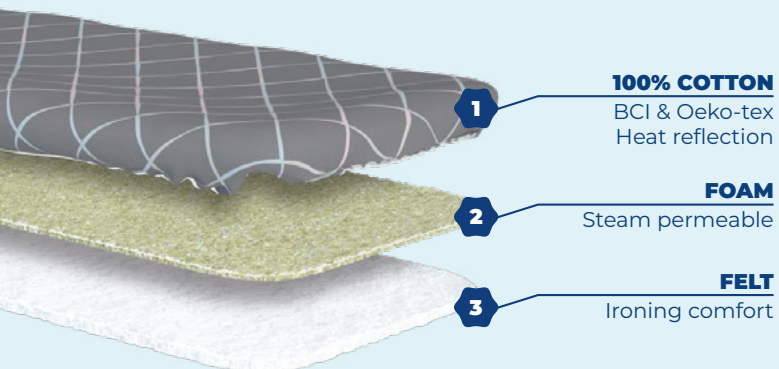

TITANIUM



EASY FIX



3 layers | couches | lagen | Lagen | warstw

Titanium treated and perforated cotton: For an optimal heat reflection and a better steam diffusion.

3 layers | couches | lagen | Lagen | warstw

Easy & efficient application: produced with an elastic hem for a quick and easy application of the cover.

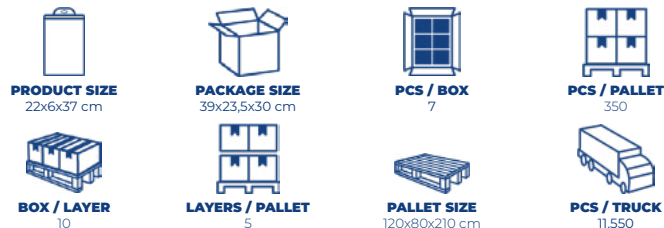
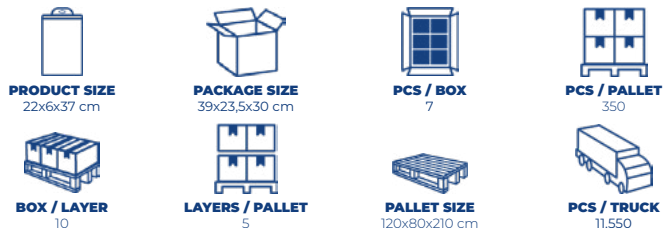

Taille 1 S/M	REF. 630	EAN: 8710225006306
Taille 2 L/XL	REF. 631	EAN: 8710225006313

Taille 1 S/M	REF. 776	EAN: 8710225007761
Taille 2 L/XL	REF. 777	EAN: 8710225007778

* Non binding photos

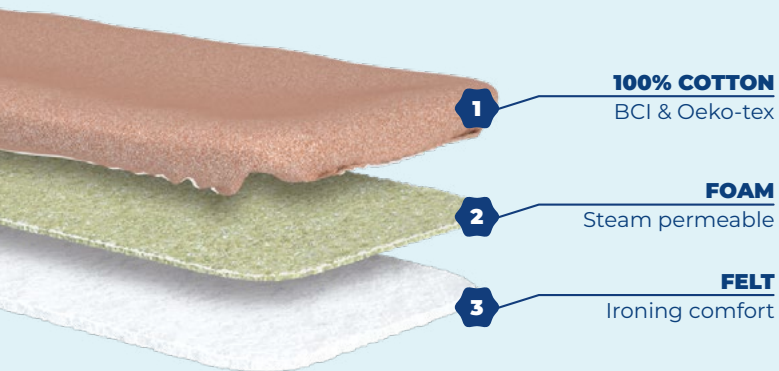

100% COTTON

50% recycled
BCI & Oeko-tex

FELT

80% recycled

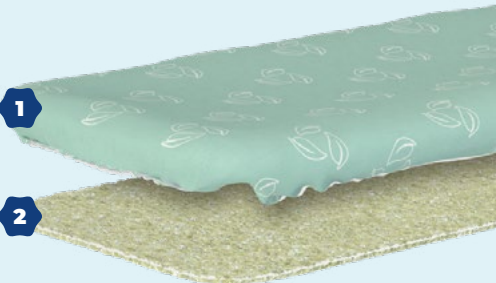

100% PARKING



ECO-RESPONSIBLE



3 layers | couches | lagen | Lagen | warstw

100% Special treated aluminized & perforated ironing board cover for ironing safety, resists 200°C heating up till 10 minutes.

2 layers | couches | lagen | Lagen | warstw

With respect for the environment Widex offers you an environment friendly ironing board cover. Composed of 67% recycled materials.

PRODUCT SIZE 22x6x37 cm	PACKAGE SIZE 39x23,5x30 cm	PCS / BOX 7	PCS / PALLET 350
BOX / LAYER 10	LAYERS / PALLET 5	PALLET SIZE 120x80x210 cm	PCS / TRUCK 11.550

PRODUCT SIZE 22x6x37 cm	PACKAGE SIZE 39x23,5x30 cm	PCS / BOX 7	PCS / PALLET 350
BOX / LAYER 10	LAYERS / PALLET 5	PALLET SIZE 120x80x210 cm	PCS / TRUCK 11.550

Taille 1 S/M	REF. 778	EAN: 8710225007785
Taille 2 L/XL	REF. 779	EAN: 8710225007792

Taille 1 S/M	REF. 1186	EAN: 8710225011867
Taille 2 L/XL	REF.1187	EAN: 8710225011874

* Non binding photos

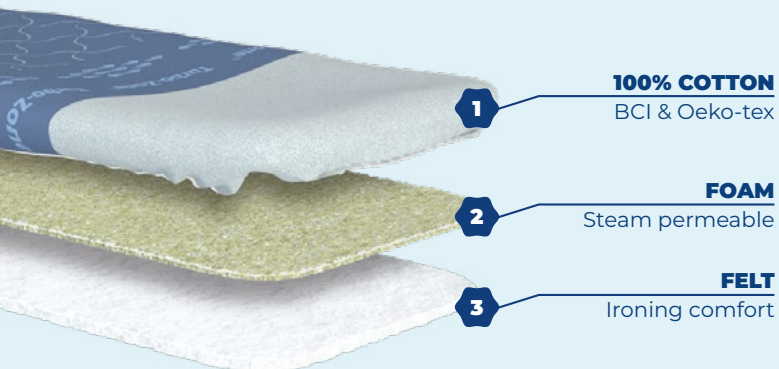

100% COTTON

BCI & Oeko-tex

FOAM

Steam permeable

FELT

Ironing comfort

ALUMINUM FOIL

Heat reflect

FOAM

Steam permeable

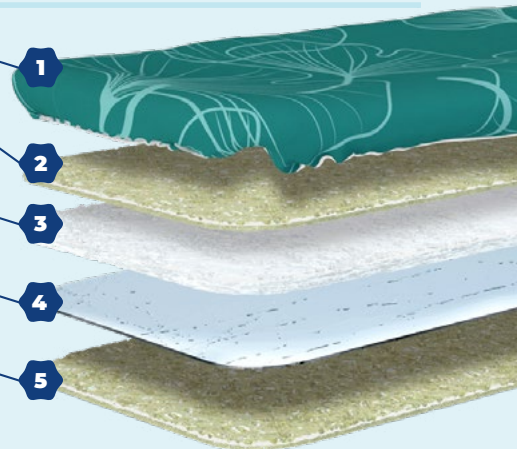

PARKING & TURBOZONE



ACTIVE



3 layers | couches | lagen | Lagen | warstw

5 layers | couches | lagen | Lagen | warstw

Parking zone: Safety zone for iron. Resists 200°C up to 10 minutes. Gliding strip with silicons: It provides a better movement of the iron.

Triple action: Avoids condensation (no more water drops on the floor), reflects heat & provides a better glide of the iron.

PRODUCT SIZE 22x6x37 cm	PACKAGE SIZE 39x23,5x30 cm	PCS / BOX 7	PCS / PALLET 350
BOX / LAYER 10	LAYERS / PALLET 5	PALLET SIZE 120x80x210 cm	PCS / TRUCK 11.550

PRODUCT SIZE 22x9x37 cm	PACKAGE SIZE 39x23,5x30 cm	PCS / BOX 4	PCS / PALLET 200
BOX / LAYER 10	LAYERS / PALLET 5	PALLET SIZE 120x80x210 cm	PCS / TRUCK 6.600

Taille 1 S/M	REF. 731	EAN: 8710225007310
Taille 2 L/XL	REF. 732	EAN: 8710225007327

Taille 1 S/M	REF. 647	EAN: 8710225006474
Taille 2 L/XL	REF. 648	EAN: 8710225006481

* Non binding photos



COVER

Place a cover of your choice over the felt layer

FELT

Extreme comfort



FELT UNDERLAY



400 gr

Add extra comfort to your ironing board cover with this extra thick molton underlay.



Universal

REF. 625

EAN: 8710225006252



[Click to see the video](#)

Save time for the fun things in life

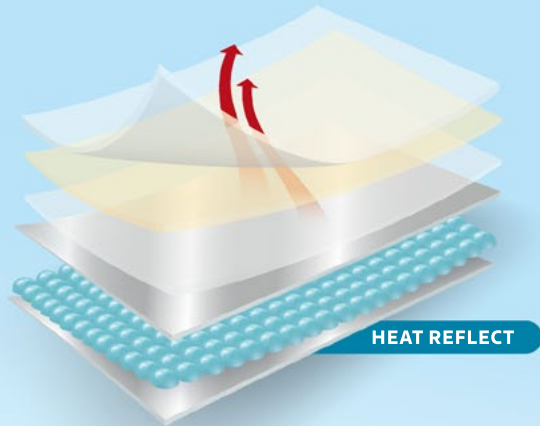

No more water drops on your floor

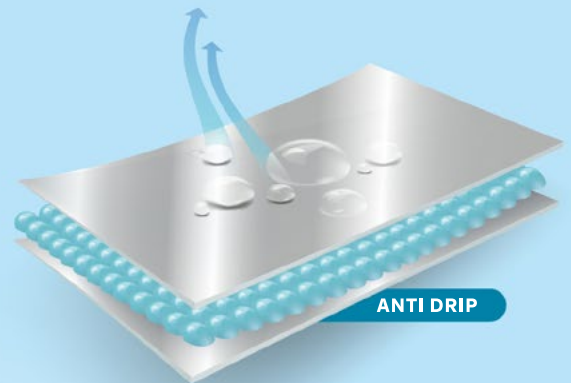

Extremely comfortable ironing

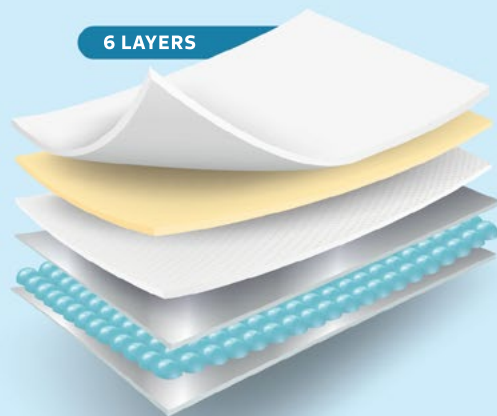

airpro [®] TECHNOLOGY	
Time saving*	Anti drip
<p>REDUCED IRONING TIME INDEPENDENTLY TESTED BY HOHENSTEIN</p> <p>TEST REPORT 24.1106673</p>	

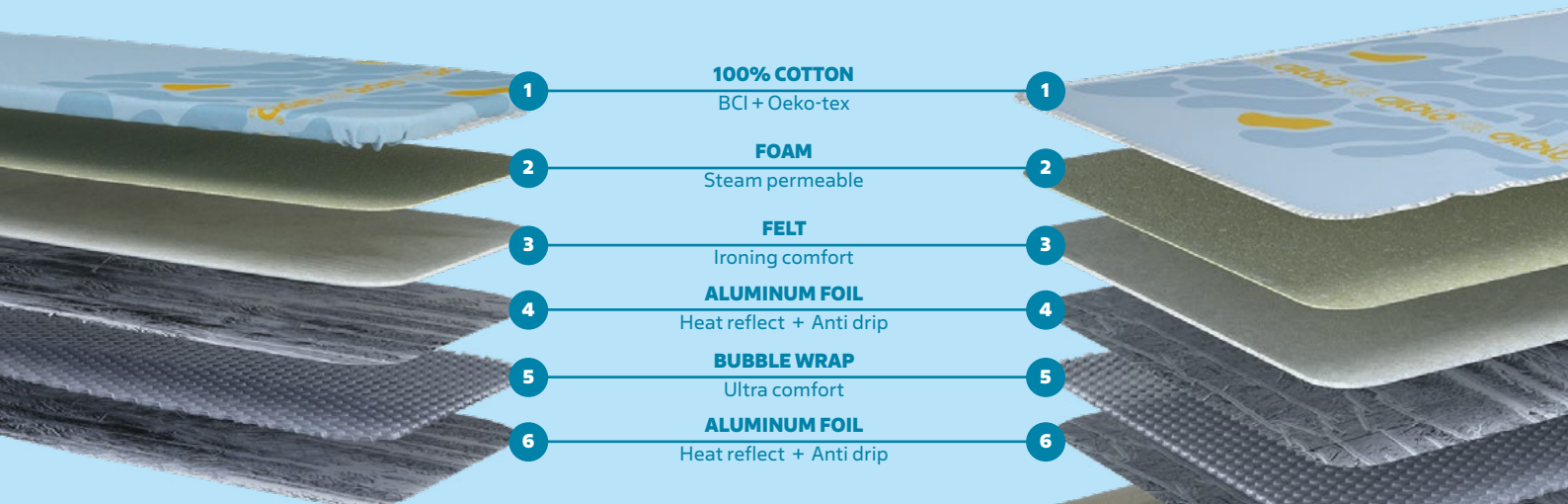

- 1 **100% COTTON**
BCI + Oeko-tex
- 2 **FOAM**
Steam permeable
- 3 **FELT**
Ironing comfort
- 4 **ALUMINUM FOIL**
Heat reflect + Anti drip
- 5 **BUBBLE WRAP**
Ultra comfort
- 6 **ALUMINUM FOIL**
Heat reflect + Anti drip



S/M
S1/T1

L/XL
S2/T2

130x65



6 layers / couches / lagen / Lagen / warstwy

Avoids condensation, reflects heat and provides a better glide of the iron.
Ultra comfort because of the bubblewrap layer.

PRODUCT SIZE 22x9x37 cm	PACKAGE SIZE 39x23,5x30 cm	PCS / BOX 4	PCS / PALLET 200	BOX / LAYER 10	LAYERS / PALLET 5	PALLET SIZE 120x80x210 cm	PCS / TRUCK 6.600

Taille 1 S/M	REF. 969	EAN: 8710225009697
Taille 2 L/XL	REF. 970	EAN: 8710225009703
Ironing blanket 130x65 cm	REF.649	EAN: 8710225006498

* Non binding photos

IRONING BOARDS

We have a broad range of ironing boards in all different sizes and price ranges. Some of them include special features like a built-in clothes hanger or a retractable iron rest. Also incredibly popular and handy are the sleeve and table ironing board. With our product range we guarantee the perfect ironing experience for everyone!



CONFORME À LA
NORME
NF D80-010



PRIMA 110 X 33

Perforated 110 x 33 cm board
Legs: steel tubes Ø 19 mm, with 4 skidproof feet
Height of ironing: 88 cm
Locked leg at the closed position
Cover: 100% cotton fabric on foam

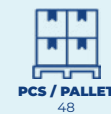

REF. 944

EAN: 8710225009444

* Non binding photos

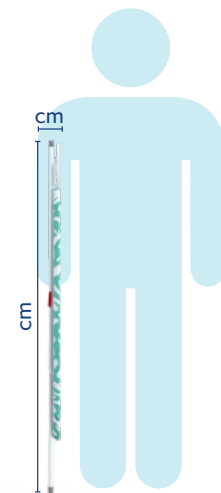

CONFORME À LA
NORME
NF D80-010

BASIC 110 X 33

-
-
-

Cover:

REF.

EAN:



* Non binding photos



CONFORME À LA
NORME
NF D80-010

BASIC 120 X 38

-
-
-

Cover:

REF.

EAN:



* Non binding photos

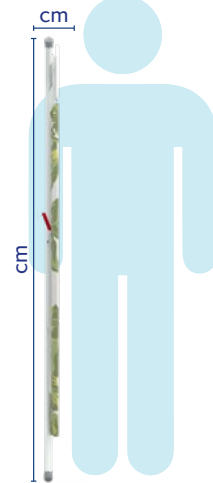

CONFORME À LA
NORME
NF D80-010

BASELINE PRO 114 X 36

-
-
-

Cover:

REF. **EAN:**



* Non binding photos

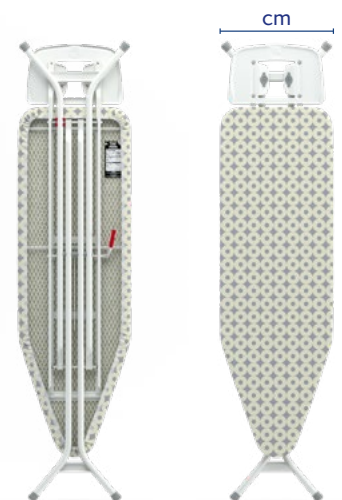
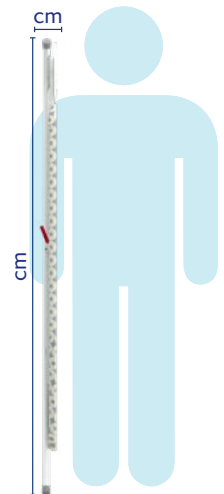









CONFORME À LA
NORME
NF D80-010

BASELINE PRO 120 X 38

-
-
-
-

Cover:

REF. _____ **EAN:** _____

 PRODUCT SIZE --cm	 PACKAGE SIZE --cm	 PCS / BOX -	 PCS / PALLET -	 BOX / LAYER -
 LAYERS / PALLET -	 PALLET SIZE -cm	 PCS / 40'FT -	 PCS / TRUCK -	

* Non binding photos

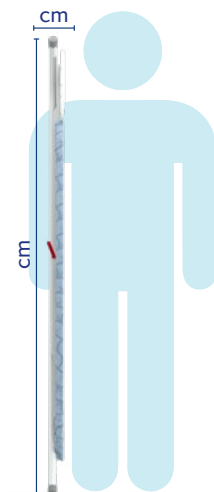

CONFORME À LA
NORME
NF D80-010

BASELINE PRO 120 X 42

-
-
-

Cover:

REF.

EAN:



* Non binding photos

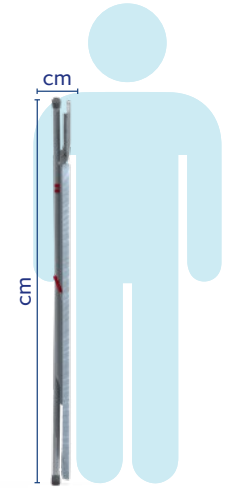

CONFORME À LA
NORME
NF D80-010

COMPACT 115 X 42

—
—
—
—

Cover:

REF.

EAN:





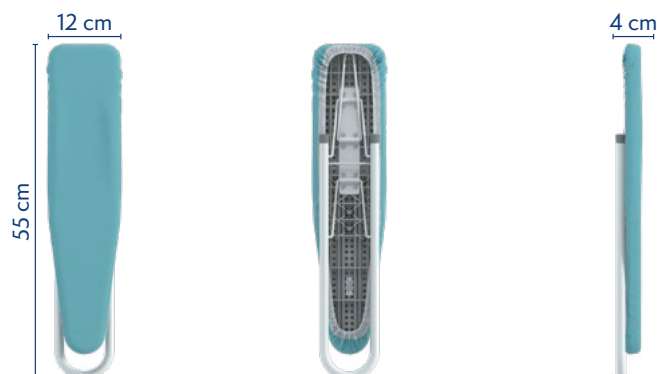
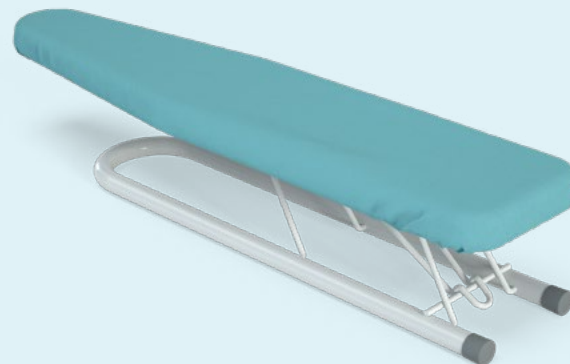





* Non binding photos



LITTLE 70 X 32 CM

Table ironing board









			
PRODUCT SIZE 70x32x2 cm	PACKAGE SIZE 71x33x13 cm	PCS / BOX 6	PCS / PALLET 234
			
BOX / LAYER 3	LAYERS / PALLET 13	PALLET SIZE 120x80x184 cm	PCS / TRUCK 7722

REF. 797

EAN: 8710225007976

JEANETTE 51 X 12 CM

Ironing sleeve board

			
PRODUCT SIZE 55x12x4 cm	PACKAGE SIZE 56x35x12 cm	PCS / BOX 10	PCS / PALLET 520
			
BOX / LAYER 4	LAYERS / PALLET 13	PALLET SIZE 120x80x171 cm	PCS / TRUCK 17160

REF. 616

EAN: 8710225006160

[Click to see the video](#)

1

Very strong and stable iron holder

Thanks to the support bars that run from the tip of the ironing board to the iron holder.



2

Child Safety Lock

Unintentional unlocking is impossible thanks to the specific design of the gear mechanism



3

AIRPRO[®] IRONING COVER

*Time-saving and energy-efficient.
Achieve fast and perfect ironing results.*

The AIRPRO[®] lining provides optimal comfort with an air cushion effect, reflects heat, redirects steam, and prevents condensation buildup.



airpro [®] TECHNOLOGY	
Time saving*	Anti drip
<p>REDUCED IRONING TIME INDEPENDENTLY TESTED BY HOHENSTEIN</p> <p>TEST REPORT 24.1106673</p>	

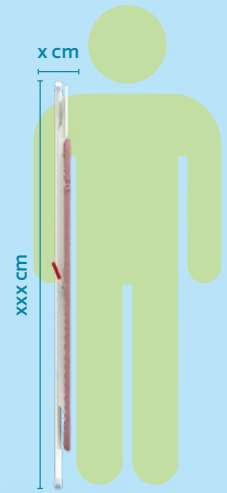

CONFORME À LA
NORME
NF D80-010

airpro S-110 X31

Avoids condensation, reflects heat and provides a better glide of the iron.
Ultra comfort because of the bubblewrap layer.



PRODUCT SIZE
-cm



PACKAGE SIZE
-cm



PCS / BOX



PCS / PALLET



BOX / LAYER



LAYERS / PALLET



PALLET SIZE
-cm



PCS / TRUCK

REF. xxx

EAN: xxxxxxxxxxxxxx

* Non binding photos

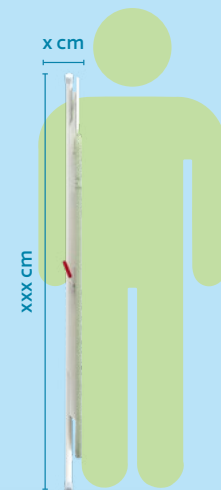

CONFORME À LA
NORME
NF D80-010

airpro M-114 X36

Avoids condensation, reflects heat and provides a better glide of the iron.
Ultra comfort because of the bubblewrap layer.



PRODUCT SIZE
-cm



PACKAGE SIZE
-cm



PCS / BOX



PCS / PALLET



BOX / LAYER



LAYERS / PALLET



PALLET SIZE
-cm



PCS / TRUCK

REF. xxx

EAN: xxxxxxxxxxxxxx

* Non binding photos

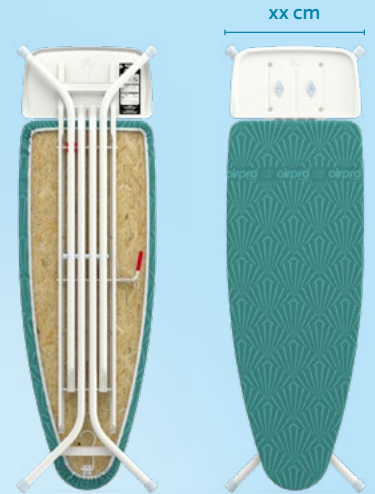
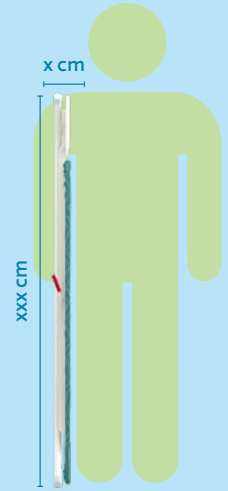

CONFORME À LA
NORME
NF D80-010

airpro COMPACT 115 X 42

Avoids condensation, reflects heat and provides a better glide of the iron.
Ultra comfort because of the bubblewrap layer.



PRODUCT SIZE
-cm



PACKAGE SIZE
-cm



PCS / BOX



PCS / PALLET



BOX / LAYER



LAYERS / PALLET



PALLET SIZE
-cm



PCS / TRUCK

REF.xxx

EAN: xxxxxxxxxxxxxx

* Non binding photos

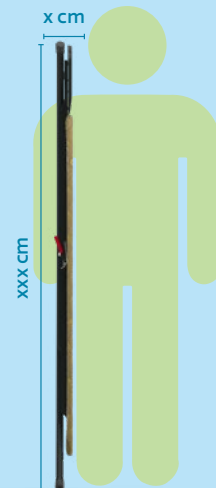

CONFORME À LA
NORME
NF D80-010

airpro L-120 X 42

Avoids condensation, reflects heat and provides a better glide of the iron.
Ultra comfort because of the bubblewrap layer.



PRODUCT SIZE
-cm



PACKAGE SIZE
-cm



PCS / BOX



PCS / PALLET



BOX / LAYER



LAYERS / PALLET



PALLET SIZE
-cm



PCS / TRUCK

REF. xxx

EAN: xxxxxxxxxxxxxx

* Non binding photos

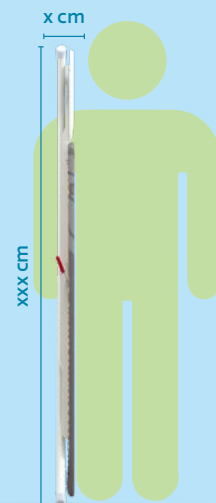

CONFORME À LA
NORME
NF D80-010

airpro XL-125 X 52

Avoids condensation, reflects heat and provides a better glide of the iron.
Ultra comfort because of the bubblewrap layer.



PRODUCT SIZE
-cm



PACKAGE SIZE
-cm



PCS / BOX



PCS / PALLET



BOX / LAYER



LAYERS / PALLET



PALLET SIZE
-cm



PCS / TRUCK

REF. xxx

EAN: xxxxxxxxxxxxxx

* Non binding photos

Hotel

Specifically for the hotel market, we have developed two ironing boards. They are compact and feature a rotating iron holder that also functions as a hook.



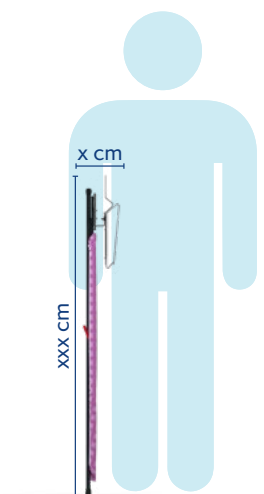









CONFORME À LA
NORME
NF D80-010

BASELINE PRO - HOTEL 110 X 31

REF. _____
Cover: _____

REF. _____ **EAN:** _____

 PRODUCT SIZE --cm	 PACKAGE SIZE --cm	 PCS / BOX -	 PCS / PALLET -	 BOX / LAYER -
	 LAYERS / PALLET -	 PALLET SIZE -cm	 PCS / 40'FT -	 PCS / TRUCK -

* Non binding photos



CONFORME À LA
NORME
NF D80-010

airpro HOTEL - 110 X 31

Avoids condensation, reflects heat and provides a better glide of the iron.
Ultra comfort because of the bubblewrap layer.



PRODUCT SIZE
-cm



PACKAGE SIZE
-cm



PCS / BOX



PCS / PALLET



BOX / LAYER



LAYERS / PALLET



PALLET SIZE
-cm



PCS / TRUCK

REF. xxx

EAN: xxxxxxxxxxxxxx

DRYING RACKS

Our drying racks are built for stability and durability—the two most essential qualities of a great drying rack.

Even when fully loaded with laundry, they remain extremely stable. Some models feature wheels for effortless mobility, while our balcony drying rack comes with an extra-sturdy suspension bracket for secure hanging.

Crafted from lightweight aluminum, our drying racks are easy to handle yet impressively strong.

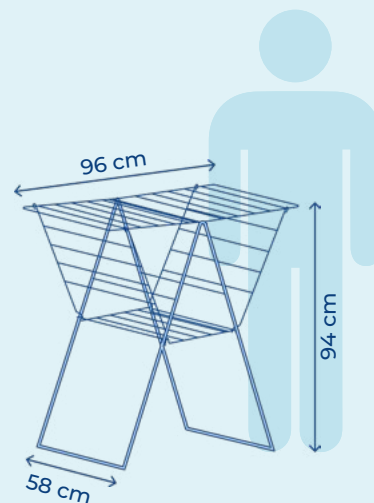
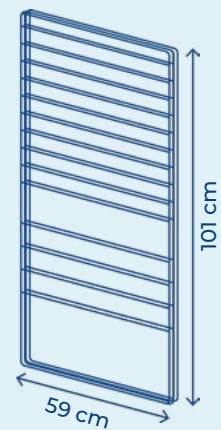
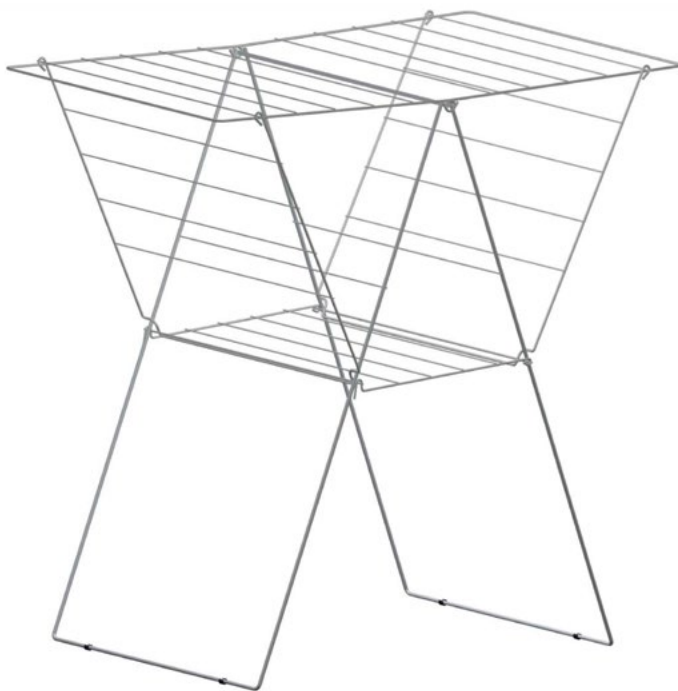

ECO DRYING RACK - 16M

- Multi-positions
- Plasticized steel wires and aluminium tubes for a better resistance
- Accessories not warranted

PRODUCT SIZE
59x4,5x101 cm

PACKAGE SIZE
60x20x102 cm

PCS / BOX
5

PCS / PALLET
40

BOX / TRUCK
8

LAYERS / PALLET
1

PALLET SIZE
120x80x117 cm



PCS / 40'FT
960

PCS / TRUCK
1.320

REF. 997

EAN: 8710225009970

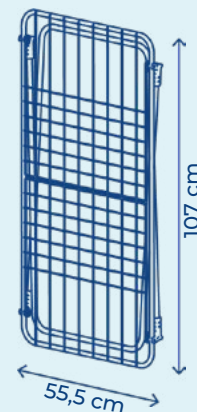
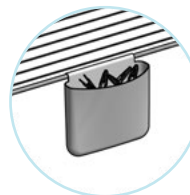
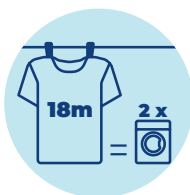
* Non binding photos



DRYING RACK - 18M

- Easy to use
- Totally recyclable
- Storage pocket
- Stabilising corners & reinforced hinges
- Wheels
- Plasticized steel wires and aluminium tubes for a better resistance
- Accessories not warranted

REF. T162

EAN: 8710225011621



PRODUCT SIZE
55,5x6x107 cm



PACKAGE SIZE
58x40x110 cm



PCS / BOX
7



PCS / PALLET
28



BOX / LAYER
4



LAYERS / PALLET
1



PALLET SIZE
120x80x125 cm



PCS / 40'FT
672



PCS / TRUCK
924

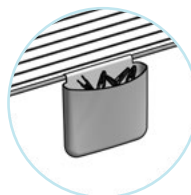
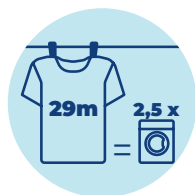
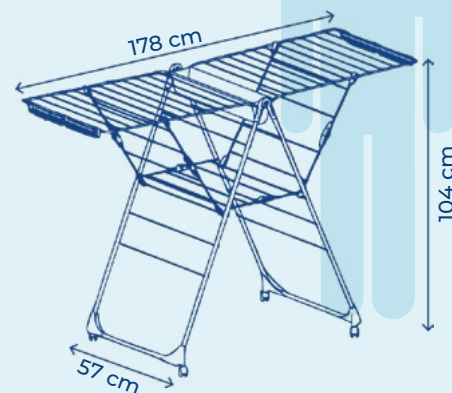
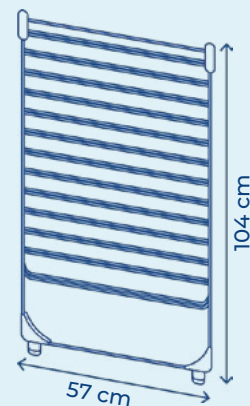

PREMIUM DRYER - 29M

- Easy opening and closing
- Reinforced hinges + security locking
- Pegs basket
- Hanger & sock-dryer
- Wheels
- Plasticized steel wires and aluminium tubes for a better resistance
- Accessories not warranted

REF. 998



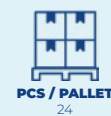

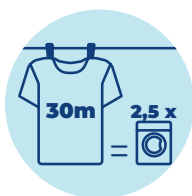
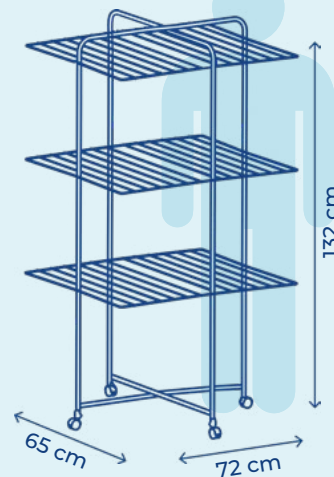
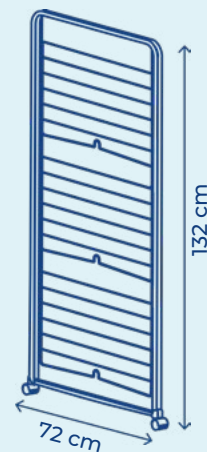
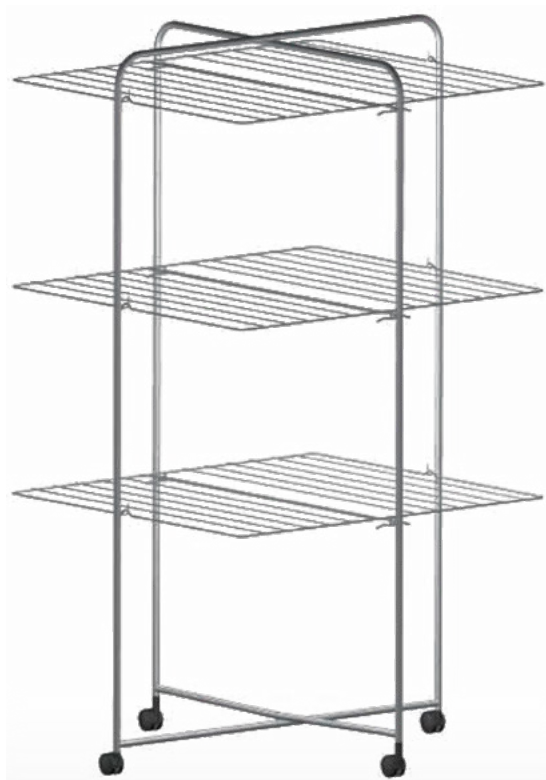



EAN: 8710225009987





DRYING RACK TOWER - 30M

- 3 shelves - Multipositions
- Wheels
- Plasticized steel wires and aluminium tubes for a better resistance
- Accessories not warranted

 PRODUCT SIZE 72x1.5x128 cm	 PACKAGE SIZE 72.5x10x129 cm	 PCS / BOX 6	 PCS / PALLET 72	 BOX / TRUCK 12
	 LAYERS / PALLET 1	 PALLET SIZE 82x120x144 cm	 PCS / 40'FT 1.728	 PCS / TRUCK 2.376

REF. 999

EAN: 8710225009994

* Non binding photos

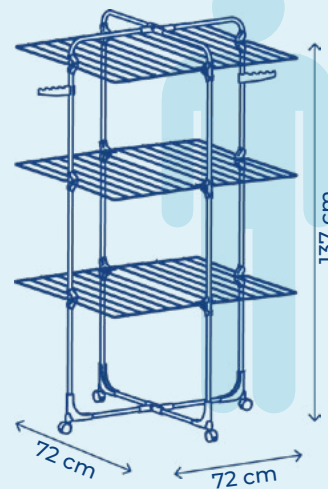
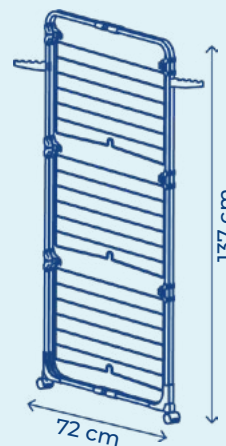

DRYING RACK TOWER - 34M

- Easy to use
- Totally recyclable
- 3 shelves - Multipositions
- Hanger rack
- Wheels
- Plasticized steel wires and aluminium tubes for a better resistance
- Accessories not warranted

REF. 1163

EAN: 8710225011638

PRODUCT SIZE
72x4,5x136 cm

PACKAGE SIZE
72x18x132 cm

PCS / BOX
3

PCS / PALLET
18



BOX / TRUCK
6

LAYERS / PALLET
1

PALLET SIZE
125x80x147 cm

PCS / 40'FT
432

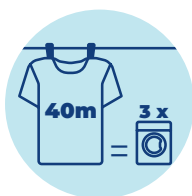
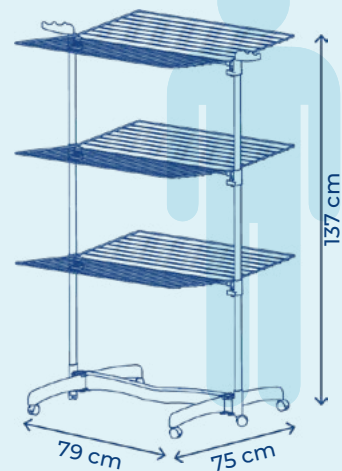
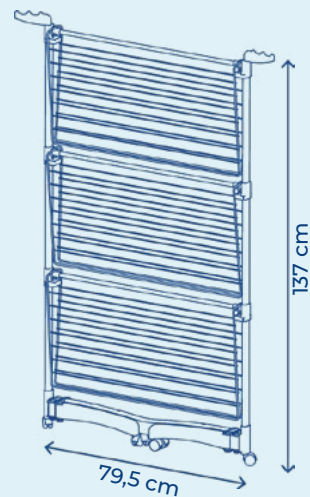
PCS / TRUCK
594



DRYING RACK TOWER - 40M

- Easy to use
- Totally recyclable
- 3 shelves
- Hanger rack
- Wheels
- Plasticized steel wires and aluminium tubes for a better resistance
- Accessories not warranted

REF. 1000

EAN: 8710225010006



PRODUCT SIZE
79x6x132,5 cm



PACKAGE SIZE
80x19,5x133 cm



PCS / BOX
3



PCS / PALLET
18



BOX / TRUCK
6



LAYERS / PALLET
1



PALLET SIZE
120x80x148 cm



PCS / 40'FT
432



PCS / TRUCK
594

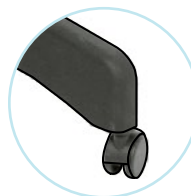
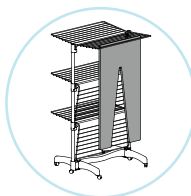
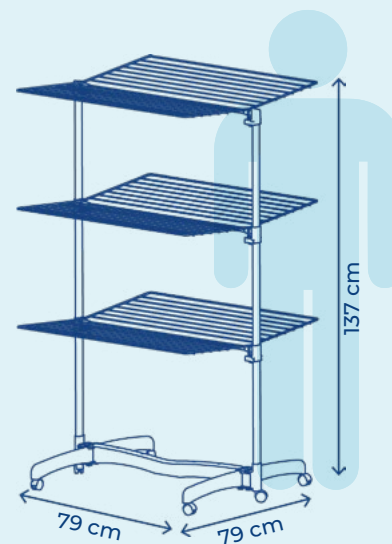
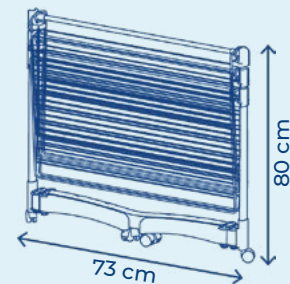

DRYING RACK TOWER - 40M

- Easy to use
- Totally recyclable
- 3 shelves - Extensible
- Foldable - Compact
- Wheels
- Plasticized steel wires and aluminium tubes for a better resistance
- Accessories not warranted

REF. 1001

EAN: 8710225010013



PRODUCT SIZE
79,5x72,5x18,5 cm



PACKAGE SIZE
80x38x67 cm



PCS / BOX
3



PCS / PALLET
18



BOX / LAYER
3



LAYERS / PALLET
3



PALLET SIZE
120x80x149 cm



PCS / 40'FT
432



PCS / TRUCK
594

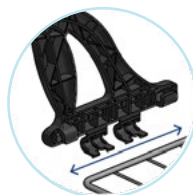
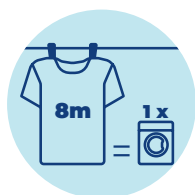
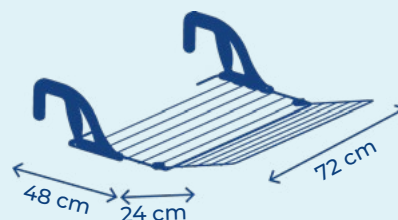

BALCONY DRYING RACK - 8M

- Folding clothes drying rack ideal for on balconies or radiators
- Totally recyclable
- Long product life
- Compact
- Plasticized steel wires and aluminium tubes for a better resistance
- Accessories not warranted

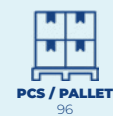

REF. T164

EAN: 8710225011645

* Non binding photos

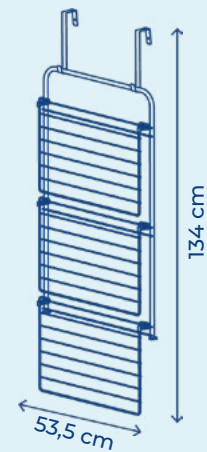
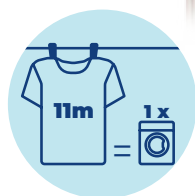

DOOR DRYING RACK - 11M

- Easy to use
- Totally recyclable
- 3 shelves - Multitposition
- Plastic locking clips & feet
- 'Shower' fixation kit (to hang the dryer on a shower cabin or door)
- Plasticized steel wires and aluminium tubes for a better resistance
- Accessories not warranted

REF. 1002

EAN: 8710225010020



PRODUCT SIZE
53,5x5x114,5 cm



PACKAGE SIZE
60x26x88 cm



PCS / BOX
8



PCS / PALLET
48



BOX / LAYER
3



LAYERS / PALLET
2



PALLET SIZE
120x80x103 cm



PCS / 40'FT
1.152



PCS / TRUCK
1.584

ACCESSORIES

These accessories are designed to make ironing easier than ever. Ensure a perfect fit for your ironing board cover with the cover tensioners and Carl cord winder. Or take your ironing to the next level with Shirtmeister—your ultimate ironing companion.

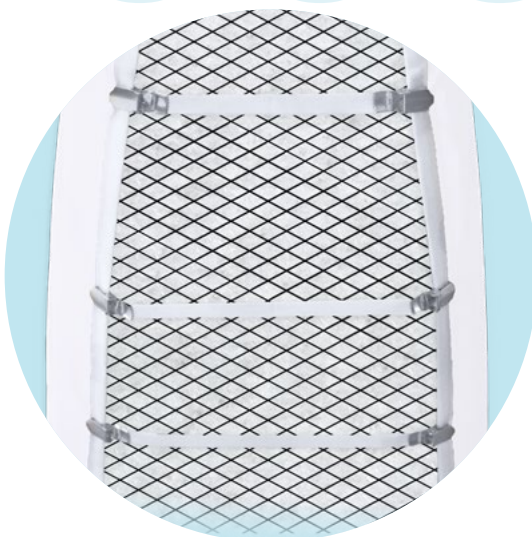

COVER TENSIONERS

CARL CORD WINDER

3x pieces | pièces | stuks | Stücke | sztuki

1x pieces | pièces | stuks | Stücke | sztuk



PRODUCT SIZE
12x4,3x4,3 cm



PACKAGE SIZE
22.5x13x9.5 cm



PCS / BOX
10



PCS / PALLET
5.100



PRODUCT SIZE
4,2x2,5x5,2 cm



PACKAGE SIZE
27x14x9 cm



PCS / BOX
48



PCS / PALLET
21.120



BOX / LAYER
30



LAYERS / PALLET
17



PALLET SIZE
120x80x177 cm



PCS / TRUCK
168.300



BOX / LAYER
20



LAYERS / PALLET
22



PALLET SIZE
120x80x203 cm



PCS / TRUCK
696.960

REF. 918

EAN: 8710225009185

Customs: 63079010

REF. 1073

EAN: 8710225010730



CLEANING STICK

50 g



PRODUCT SIZE
12x4,3x4,3 cm



PACKAGE SIZE
27x14x9 cm



PCS / BOX
12



PCS / PALLET
3.840



BOX / LAYER
20



LAYERS / PALLET
16



PALLET SIZE
120x80x178 cm



PCS / TRUCK
126.720

REF. 707

EAN: 8710225007075

Customs: 34022090

* Non binding photos



SHIRT MEISTER®

IRONING DEVICE

MAX

Order now



**Goodbye to wrinkled shirts,
Hello to your new best friend!**



SAVES TIME



EFFORTLESS RESULTS



GREAT FOR TRAVELING



EASY TO STORE

Printed box:	1,18 kg
Pieces per printed box:	1 Max
Master carton (462x387x642 mm):	12 pieces
Pieces per pallet:	120 pieces
Pallet size (cm):	120x80x183 cm
Power:	1800 W
Ref.	SHIRTM001
EAN:	8720844021239

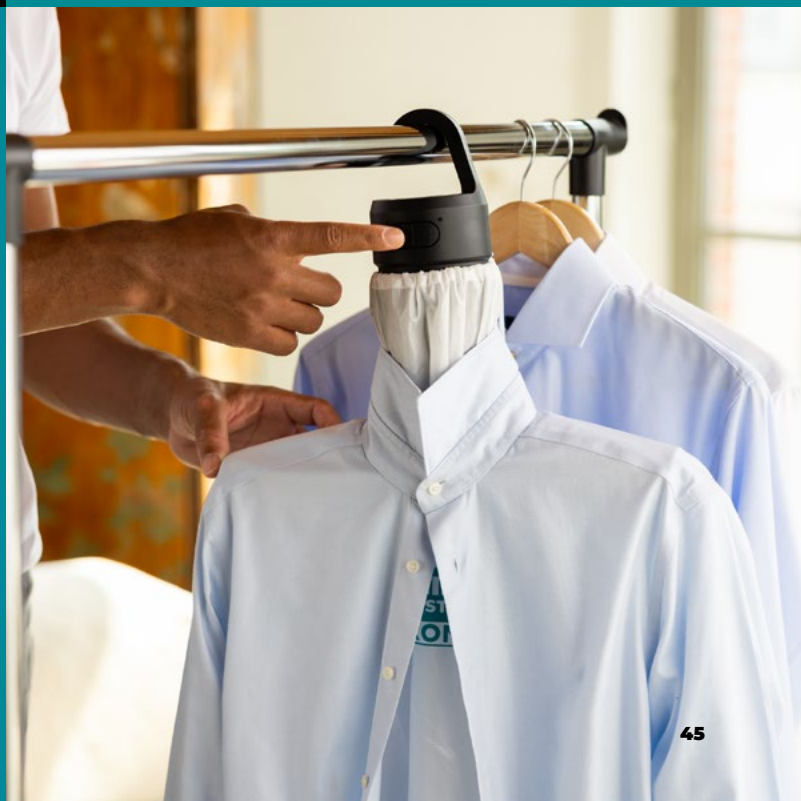

SHIRT MEISTER®

IRONING DEVICE

JACK

Order now



**Goodbye to wrinkled clothes,
Hello to your new best friend!**



ALL-IN-1



EFFORTLESS RESULTS



SILENT EDITION

Printed box:	3,6 kg
Pieces per printed box:	1 Jack
Master carton (70,5*51*38 cm):	4 pieces
Pieces per pallet:	32 pieces
Pallet size (cm):	120 x 80 x 167 cm
Power:	1400 W
Ref.	HLAU002
EAN:	8719244800025



SHOES



PANTS



SHIRTS & SWEATERS



Widemex International in a nutshell

We are a family business with a dedicated team of partners stationed in various countries around the world.

We largely produce private label ironing products and focus on quality, innovation and sustainability. We have a broad customer base worldwide consisting of importers, retailers, E-commerce and OEM.

For more information, please refer to our website or a personal consultation

www.widemexinternational.com

**YOUR
PARTNER IN
IRONING**

SINCE 1954

PRIVATE LABEL

iNNOVATION



1

Widemex International B.V.

Churchillaan 204b, 5705 BK Helmond, The Netherlands
+31 (0)492 509 811
+31 (0)492 545 000
info@widemexinternational.com
sales@widemex.nl

2

Sales Office France

3, Rue de Fessard F-77760 Rumont, France
+33 (0) 160 962 254
+33 (0) 160 967 983
info@widemexinternational.com
c.leang@widemex.fr

3

Widemex Poland

Ul. Maszewska 3A, 72-100 Goleniów, Poland
+48 913 920 036
+48 571 202 303
info@widemexinternational.com

4

Widemex International B.V. / Asia

Room901, Building 1, Guangzhou Friendship Commercial Building,
NO.369 Huanshi East Road, Yueexiu, Guangzhou, China 510095
+86 139 024 962 82
info@widemexinternational.com
jovipan@vip.163.com

5

Sales Office Japan

10-4, 2-chome, Hiyodoridai, Kita-ku Kobe
651-1123, Japan
+81 (0) 787 418 078
+81 (0) 787 418 130
info@widemexinternational.com



www.widemexinternational.com

widemex
i n t e r n a t i o n a l